

固態繼電器 SOLID STATE RELAY

KF0602D
KF0604D

KF06 SERIES



型號索引說明 Model No. Descriptions:

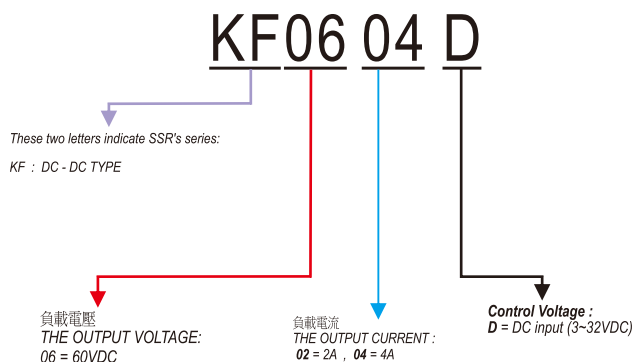

產品摘錄 PRODUCT SELECTON

輸出規格 OUTPUT SPECIFICATIONS

品名	Description	KF0602D	KF0604D
負載電壓範圍	Operating Voltage [VDC]	3-60VDC	3-60VDC
最大負載電流	Maximum Load Current [A]	2A	4A
破壞電壓	Maximum Transient Overvoltage [Vpk]	80	80
洩露電流	Maximum Off-State Leakage Current @Rated Voltage [mA]	5mA	5mA
最大瞬間承受電流	Maximum Surge Current [Adc] (10ms)	3A	8A
動作壓降	Maximum On-State Voltage Drop @ Rated Current [VDCrms]	1.5	1.5

輸入規格 INPUT SPECIFICATIONS

品名	Description	KF0602D	KF0604D
控制電壓範圍	Control Voltage Range	3-32VDC	3-32VDC
最小導通電壓	Minimum Turn-on Voltage	3.0	3.0
最大關斷電壓	Maximum Turn-off Voltage	1.0	1.0
輸入電流	Typical Input Current	15mA	15mA
最大動作時間	Maximum Turn-on Time [mSec]	Less 2m Sec	Less 2m Sec
最大關斷時間	Maximum Turn-off Time [mSec]	Less 2m Sec	Less 2m Sec

一般規格 GENERAL SPECIFICATIONS

品名	Description	KF0602D	KF0604D
輸入/輸出至外殼絕緣電壓	Dielectric Strength , Input-Output Base (50/60Hz)	-	-
輸入/輸出絕緣電壓	Dielectric Strength , Input-Output (50/60Hz)	2500	2500
絕緣電阻	Minimum Insulation Resistance	10 ⁹ ohm	10 ⁹ ohm
輸入-輸出容抗	Maximum Capacitance , Input-Output	Less 15pf	Less 15pf
工作溫度範圍	Ambient Operating Temperature Range	-20°C~+80°C	-20°C~+80°C
儲存溫度範圍	Ambient Storage Temperature Range	-40°C~+100°C	-40°C~+100°C
觸發方式	Switching Type	電晶體 (TR)	電晶體 (TR)
重量	Weight (g)	15g	15g

GENERAL NOTES

- (1) All parameters at 25°C unless otherwise specified
- (2) Dielectric strength and insulation resistance are measured between input and output
- (3) Heat sinking require ,for derating curves see next page.

等效電路圖 EQUIVALENT CIRCUIT

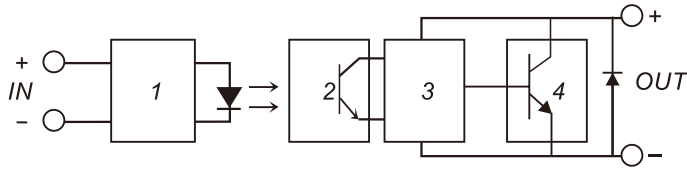

- 1.INPUT CIRCUIT
- 2.PHOTO DETECTOR
- 3.AMPLIFIER
- 4.PROTECTED CIRCUIT

外觀尺寸圖 MECHANICAL DIMENSIONS (Unit:mm)

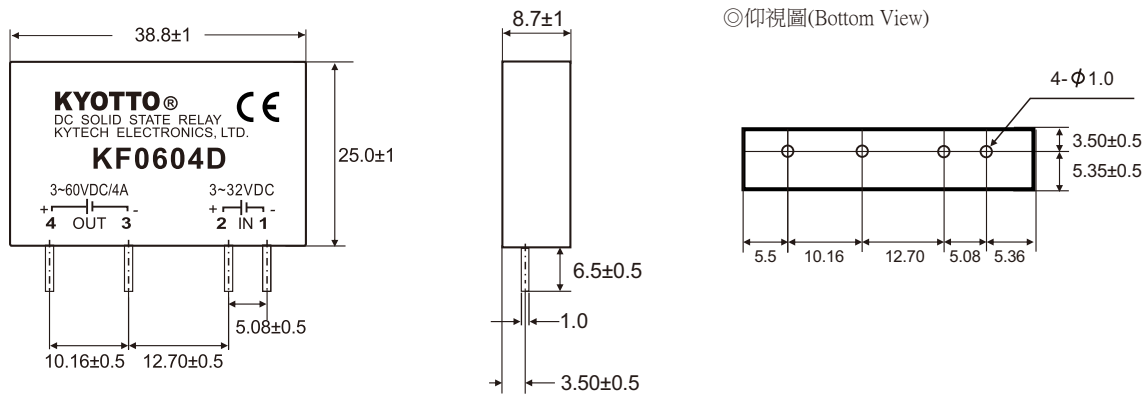

特性曲線圖 CHARACTERISTIC CURVES

CHARACTERISTIC CURVES

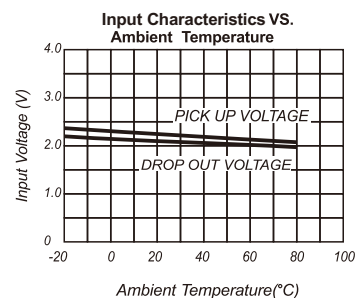
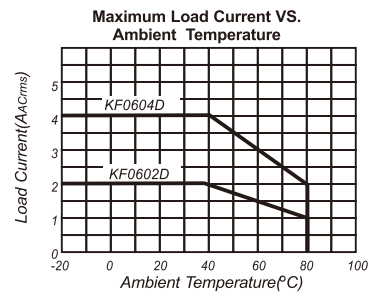
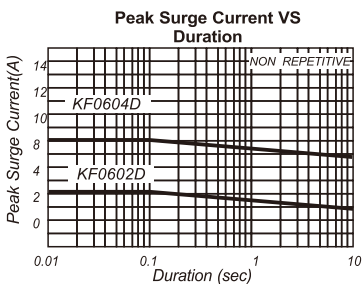
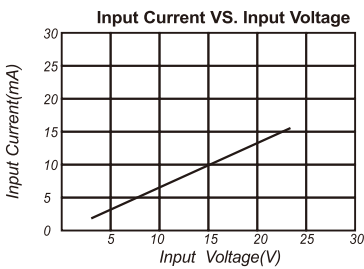

GENERAL NOTES

- (1) All parameters at 25°C unless otherwise specified
- (2) Dielectric strength and insulation resistance are measured between input and output
- (3) Heat sinking require, for derating curves see next page.